

SINGLE POINT

SINGLE POINT SPRING SUSPENSION

SP SERIES

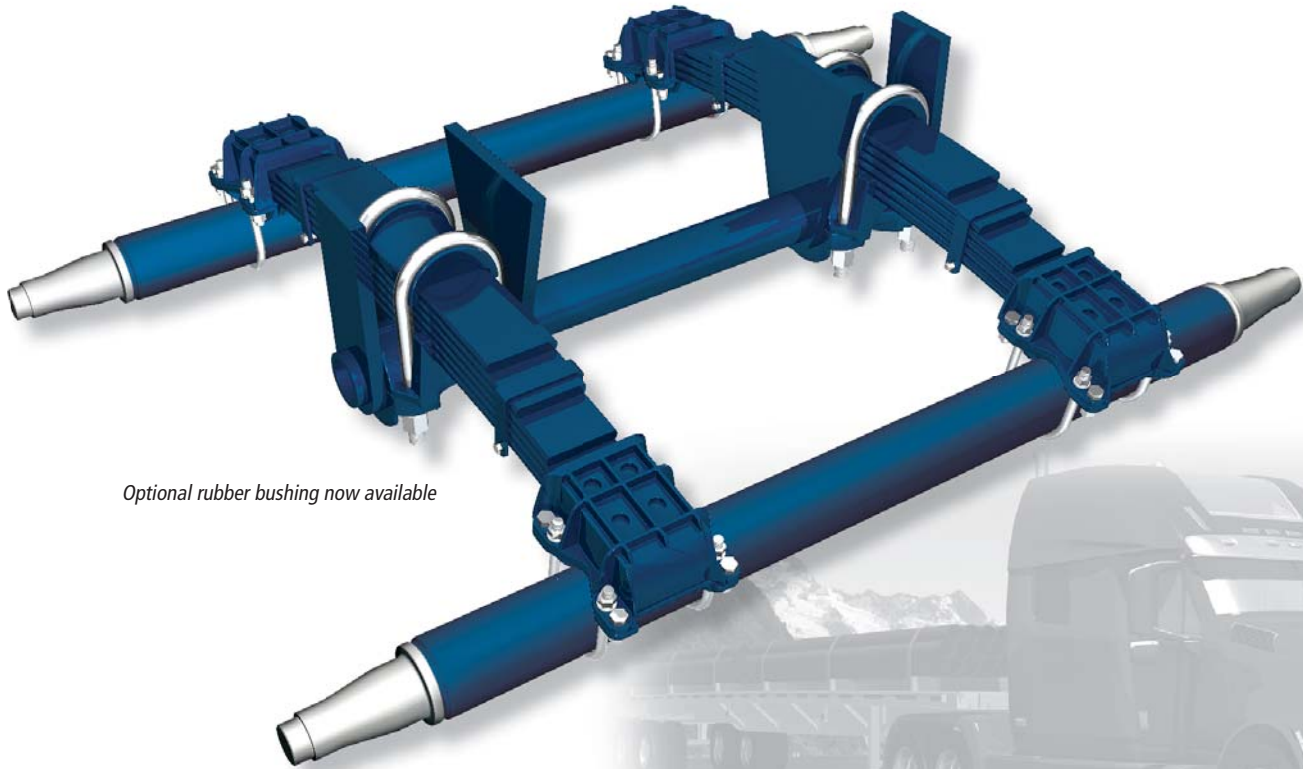

Optional rubber bushing now available



SINGLE POINT

Our **Single Point** suspension series is designed for on- and off-road trailer applications. This severe-duty suspension is available with capacities from 44,000 thru 80,000 pounds. Our rugged Single Point suspension is ideal for end dumps, side dumps, belly dumps and logging applications.

- Capacity: 44,000- thru 80,000-pounds
- Straddle mount or trunnion mount
- Severe-duty straddle plate available for 60,000-, 70,000- or 80,000-pounds
- Optional trunnion lengths available
- 5-year limited warranty*

* Contact your local Watson & Chalin representative for complete warranty terms, conditions and limitations.

For more information, call 800.445.0736



Watson & Chalin is a brand of Hendrickson

Integrated Suspension and Axle Assembly

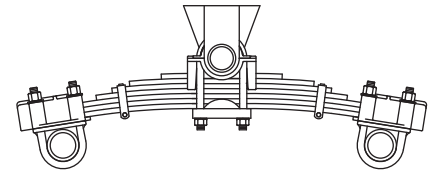
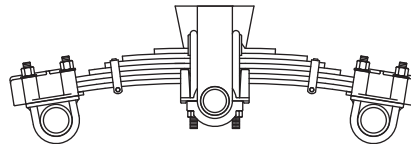
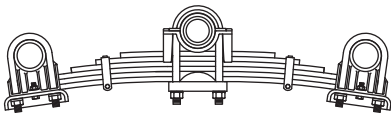
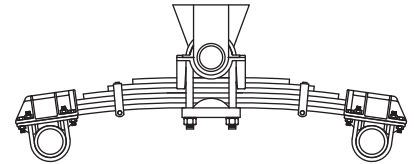
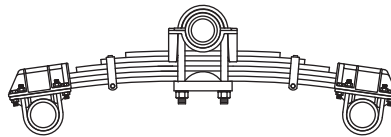
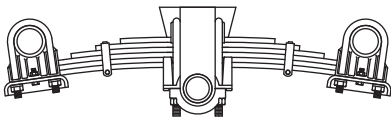
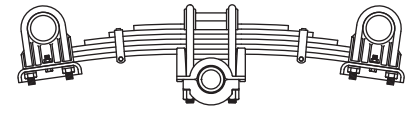
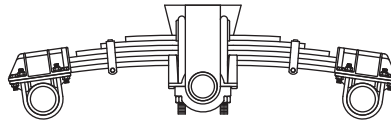
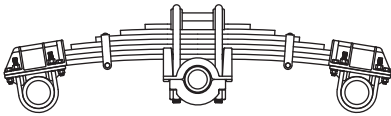

- **Available models:**
Trunnion mount, straddle mount, lightweight, heavy-duty, overslung and underslung
- **Axle centers:**
48.5- through 59.5-inch available
- **Trunnion casting:**
Covers up to 3 leaves

- **Spring capacities:**
Lightweight: 44,000 lbs. - 5-leaf
50,000 lbs. - 5-leaf
50,000 lbs. - 3-leaf
Heavy-duty: 44,000 lbs. - 6-leaf
50,000 lbs. - 7-leaf
60,000 lbs. - 9-leaf
70,000 lbs. - 10-leaf
80,000 lbs. - 12-leaf

- **Mounting pedestal heights:**
9-, 10- and 12-inch
- **Optional trunnion lengths available**
- **Custom applications available on straddle mounts, 3/8-inch T-1 thru 1-inch A36 steel**
- **Severe-duty straddle plate assemblies. Available for 60,000-, 70,000- or 80,000-pounds**

Contact Watson & Chalin at 972.547.6020 for additional information.



Watson & Chalin
725 E. University Drive, McKinney, Texas 75069
972.547.6020 • 800.445.0736 • Fax 972.542.0097
www.watsonsuspensions.com

